

## POS-300L



## *User Manual*

---

## Contents

1. General Description	3
2. Installation and use Description	4
2.1 Preparation	4
2.2 Use	4
2.3 Front panel control	5
3. External Description	7
3.1 Front Panel	7
3.2 Rear Panel	8
3.3 Connector Description	8
4. Technical Specifications	9
4.1 Physical specifications	9
4.2 Electrical specifications	9
5. Working Principles	10
5.1 Power Supply	11
5.2 Main Board	11
5.3 Power Amplifier Board	11

## 1. General Description

The POS-300L series is transmitter for Frequency Modulated audio broadcasting in a frequency modulation able to transmit in the band between 87.5 and 108 MHz with an output RF power adjustable up to a maximum of 300 W

Outstanding audio features this device has are low distortion and inter modulation values and the high signal to noise ratio. Another important feature the POS-300L series has is its great simplicity of construction and use.

The POS-300L series was designed to be modular. Its various functions are run from modules directly connected to each other with male and female connectors or with flat cables ending in connectors. This type of design makes maintenance operations and any required module replacement easier. All models are made with SMD technology.

This exciter contains a low-pass filter that reduces the harmonic emissions to below the limits allowed by international regulations, and can therefore be used as a transmitter connected directly to the antenna.

The microprocessor system includes an LCD display and push-button panel for inter action with the user, and implements the following functions:

- Setting the operating frequency
- Measurement and display of the working parameters of the transmitter

The transmitter's management software is based on a menu system. The user can navigate between the various submenus by using three push buttons: UP, DOWN and ENTER.

---

## 2. Installation and use Description

This chapter contains the necessary information for installing and using the machine. In the event any aspects are not completely clear, for example when using the machine for the first time, we recommend you carefully read the entire description contained in this manual.

### 2.1 Preparation

Unpack the exciter and before doing any other operation, be sure it has not been damaged during transport. In particular check that all the connectors are in perfect condition.

The main fuse can be accessed from the outside on the rear panel. Extract the fuse carrier with a screwdriver to check its integrity or for replacement, if necessary. The fuse to be used is this type 10A @220VAC

Check that the POS-300L switches are in the "OFF" position. The exciter has one switch for the mains power supply cable and completely interrupts the machine's mains power supply.

Connect the RF output of the exciter to the antenna cable or to a fictitious load 50 ohm.

Connect the mains cable.

Connect the earth cable.

Connect the audio cables of the signal source to the proper connectors on the back of the exciter.

### 2.2 Use

Check that the POS-300L switches are in the "ON" position.

Enter the "UP" or "DOWN" menu and "ENTER" to set the desired operating frequency.

Adjust the desired power level from the front panel.

### 2.3 Front panel control

The machine is provided with a two-line LCD display where a set of menus is shown

When turned on, the LCD display shows the predefined screen with the graphic representation of the instantaneous modulation level and indication of the direct power supplied:

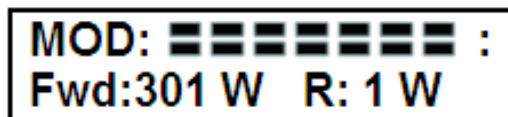

The vertical bars under "MOD" indicate the progress of the modulation in real time; the hatched bar signals the maximum nominal modulation level of 75 kHz (100%).

To change the menu, select the UP or DOWN push button, the screen that is shown in following:

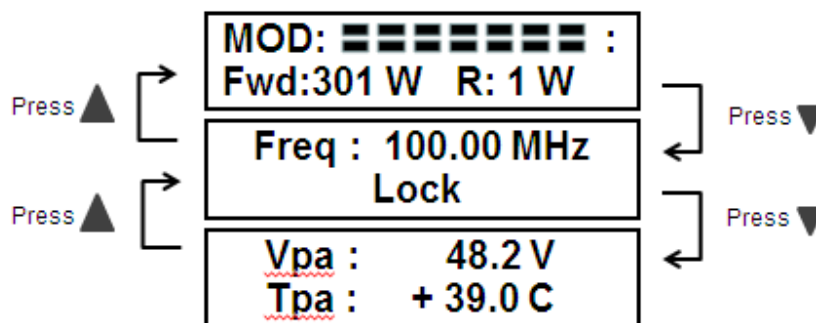

#### 2.3.1 Power setting

To change the set power level, select the menu power as below,

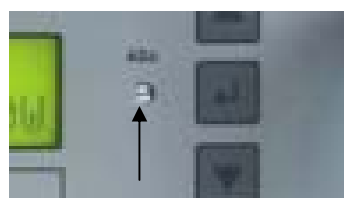
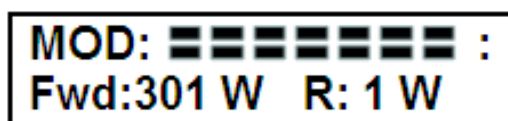

To increase the level, screw the direction to right and to reduce it, screw the direction to left.

### 2.3.2 Frequency setting

This menu lets you read and set the operating frequency.

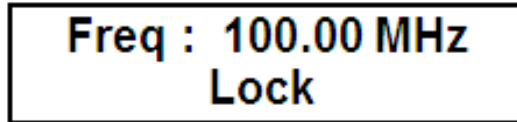

Keep the ENTER push button. The screen that is show in the modification mode is similar to the following:

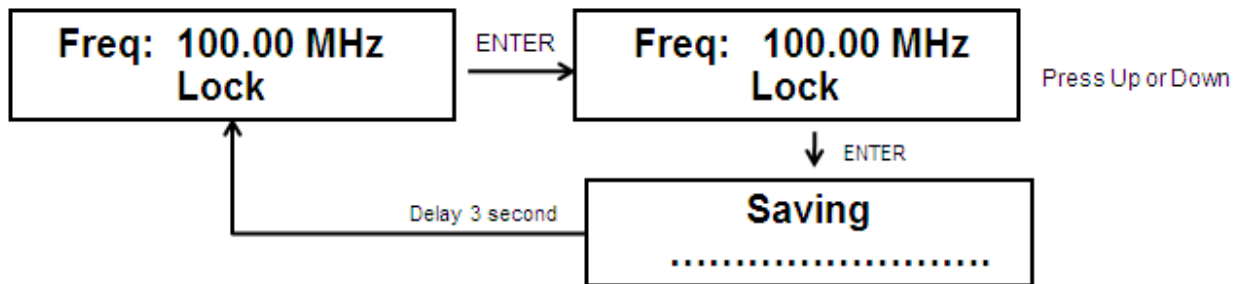

By pressing the ENTER push button, you can modify the set frequency using the UP (the frequency increases) and DOWN (the frequency decreases) push buttons. After having set a new frequency value, press the ENTER push button to confirm the choice. The exciter will release from the current frequency and it will latch onto the new operating frequency.

### 3. External Description

This chapter reports the elements of the front and rear panels of the POS-300L series with a brief description of each of them.

#### 3.1 Front Panel



[1] AIR FLOW  
[2] POWER

[3] ON  
[4] LOCK

[5] ALARM

[6] ADJ.

[7] UP  
[8] DISPLAY  
[9] DOWN  
[10] ENTER

Grid for the intake of the air flow of the forced ventilation  
ON/OFF switch. This switch disables the exciter without disconnecting the mains supply

Green LED, light when the exciter is working

Green LED, light when the PLL is locked on the working frequency

Red LED, light when the alarm function is operating (high reflect power, high SWR or high temperature)

Trim pot for power output adjustable.

Push button to change parameter display or increase value.

Liquid crystals display

Push button to change parameter display or decrease value.

Push button to confirm a parameter.

### 3.2 Rear Panel



- |               |   |
|---------------|---|
| [1] LEFT      | XLR connector, balanced Left channel input.   |
| [2] RIGHT     | XLR connector, balanced Right channel input   |
| [3] AIR FLOW  | Grid for the intake of the air flow of the forced ventilation                                     |
| [4] FUSE      | Fuse holder. Use a screwdriver to access the fuse Contains the general protection fuse rated 10 A |
| [5] PLUG      | Mains supply plug, 200 - 260V 50-60 Hz  |
| [6] RF TEST   | RF test output  |
| [7] RF OUTPUT | RF output connector, N-type, 50Ω.   |
| [8] GND       | Ground of equipment, connect to earth   |
| [9] AIR FLOW  | Grid for the air flow   |

### 3.3 Connector Description

#### 3.3.1 Audio input LEFT/RIGHT

Type: XLR female

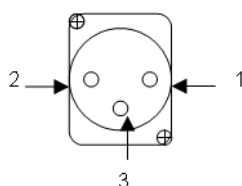

- |   |                |
|---|----------------|
| 1 | GND            |
| 2 | Positive ( + ) |
| 3 | Negative ( - ) |



## 4. Technical Specifications

### 4.1 Physical specifications

Panel size	485 mm (19") x 88 mm (2U)
Depth	550 mm
Weight	12 Kg
Working Temperature	0 °C ÷ 50 °C

### 4.2 Electrical specifications

#### General

RF output power	40 to 300 W, adjustable
RF output connector	N – type female
RF output impedance	50 Ohm
Frequency range	87.5 MHz ÷ 108 MHz
Frequency setting	software programming
Frequency step	10 KHz
Frequency stability	< ±500Hz from -10°C to 50°C
Modulation type	direct carrier modulation
Harmonics	< -75 dBc
Out of Band Emission (Spurious)	< -85 dBc
Modulation capability	< +- 75KHz
A.C. power supply	≅ 200 V ÷ 260 V
Power consumption	700 VA

#### Input

Left, Right and Mono Input	Type: XLR female balanced
Input impedance	balanced input: 10 k Ohm
Input level	0 dBm fixed
Pre emphasis	50 us (CCIR)

#### Output

RF Out	N – type female, 50 Ohm
RF test	BNC connector

#### Stereo operation

S/N FM Stereo	> 65 dB
Audio frequency response	20 Hz ÷ 15 KHz
Total harmonic distortion (THD)	≤ 0.35 %
Stereo separation	> 45 dB

## 5. Working Principles

A diagram view of the modules and connections making up the POS-300L series is shown as below.

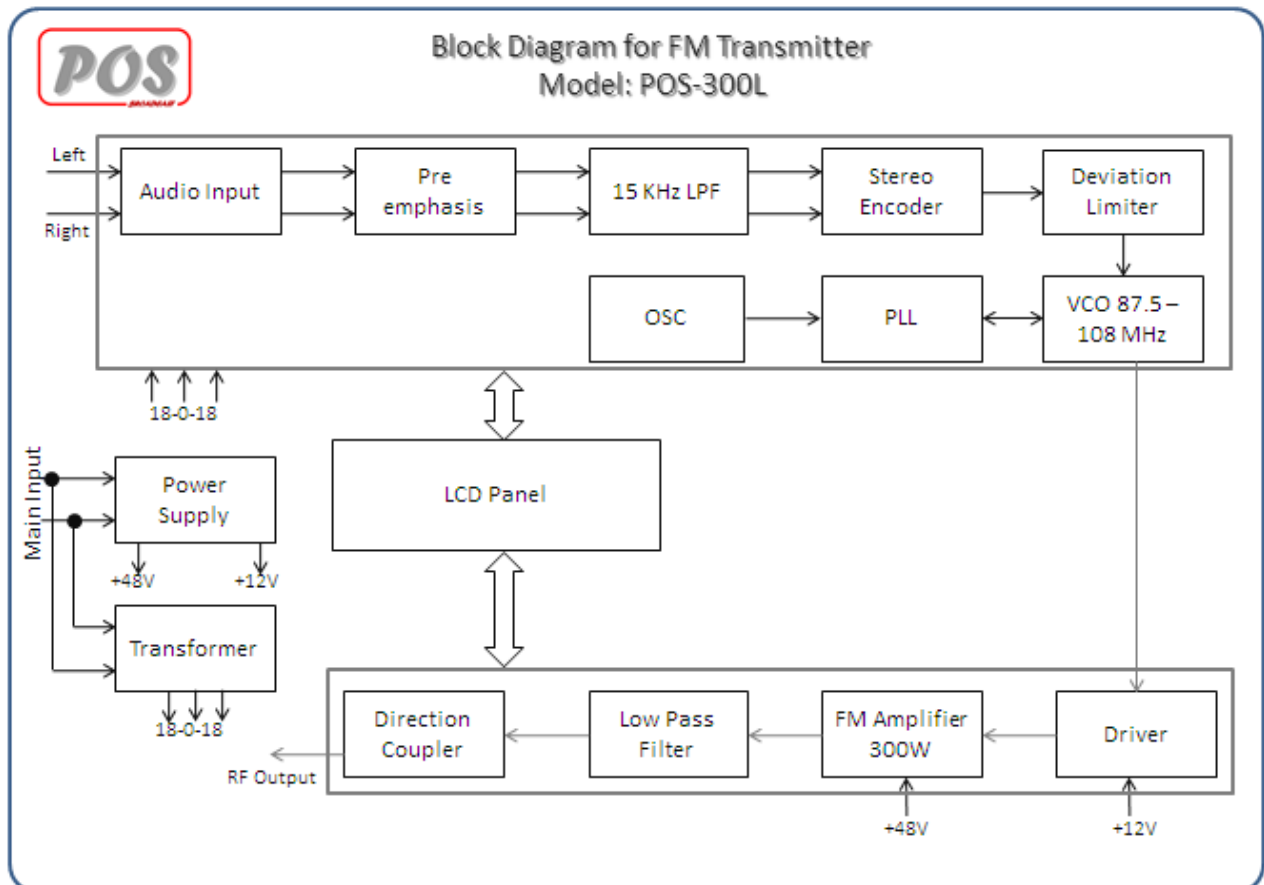

## **5.1 Power Supply**

POS-300L series power supply is a switching type of unit, and its main +18V, -18V, 12V and 48 V output feeds the RF amplifier and regulate broad of the machine. The power supply is connected to voltage between 200 and 260 V without having to make adjustments or manual settings.

## **5.2 Main Board**

### **5.2.1 Main section**

The Main board contains the microcontroller (PIC16F886) that implements the machine's control software, the display and the other components needed to control and measures.

### **5.2.2 Encoder section**

The encoder audio input section contains the circuits that perform the following functions:

- Input impedance
- 15 KHz filtering
- Pre emphasis
- Stereo multiplexing
- 19 KHz generate
- Measurement of the modulating signal

### **5.2.3 PLL section**

The PLL section of the card generates the signal in modulated radio frequency. It is based on a PLL diagram that uses an MC145170 type of integrated PLL. For frequency reference use to 10.000 MHz

### **5.2.3 VCO section**

The VCO section of the card generates the signal in fm band 87.50 – 108 MHz. It is based on a VCO diagram that uses to POS-150 to generate frequency.

## **5.3 Power Amplifier Board**

The final power stage is enclosed in a totally shielded metal container fastened in the centre of the device. The RF signal coming from the VCO, is amplified and is then sent to the final stage that sees to its final amplifications up to 300W. The amplifier is made in two stages. The first is made with RD15HVF and the last with one BLF278. In addition to the actual RF amplifier, this circuit carries out the following functions:

- Control of the power level in output, depending on the setting
- Measures direct and reflected power through directional couplers
- Low-pass filtering of the RF signal in output
- RF sample